

GOLD SD/CX 120, eff.var./cap.var. 1

Med styrenhet och batteri-
värmeväxlare/
With control unit and
coil heat exch.

Skiss visar styrenhet för aggregat med inspektionssida vänster, styrenhet för aggregat med inspektionssida höger ser något annorlunda ut, men principen är lika./ The sketch shows control unit for AHU with left-hand inspection, control unit for AHU with right-hand inspection looks slightly different, but the principle is the same.

Temperatursensoren för densitetskorrigerat luftflöde/
Temperature sensor for density corrected air flow

Utetemperatursensoren monterad mellan filter och batterivärmeåtervinnare/
Outdoor temperature sensor is fitted between the filter and the heat recovery coil

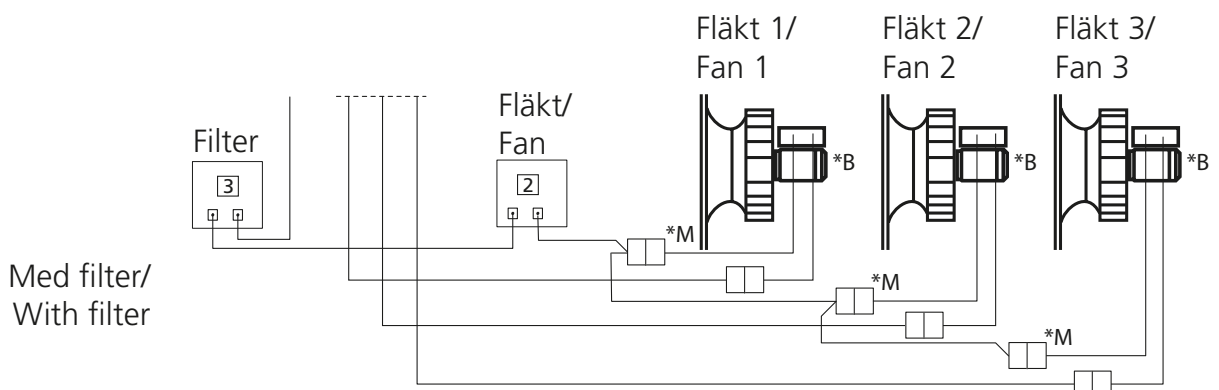
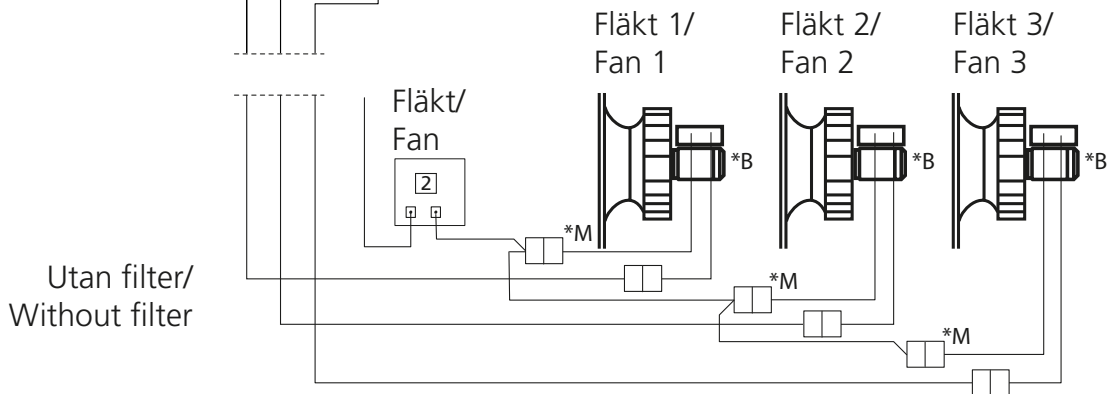
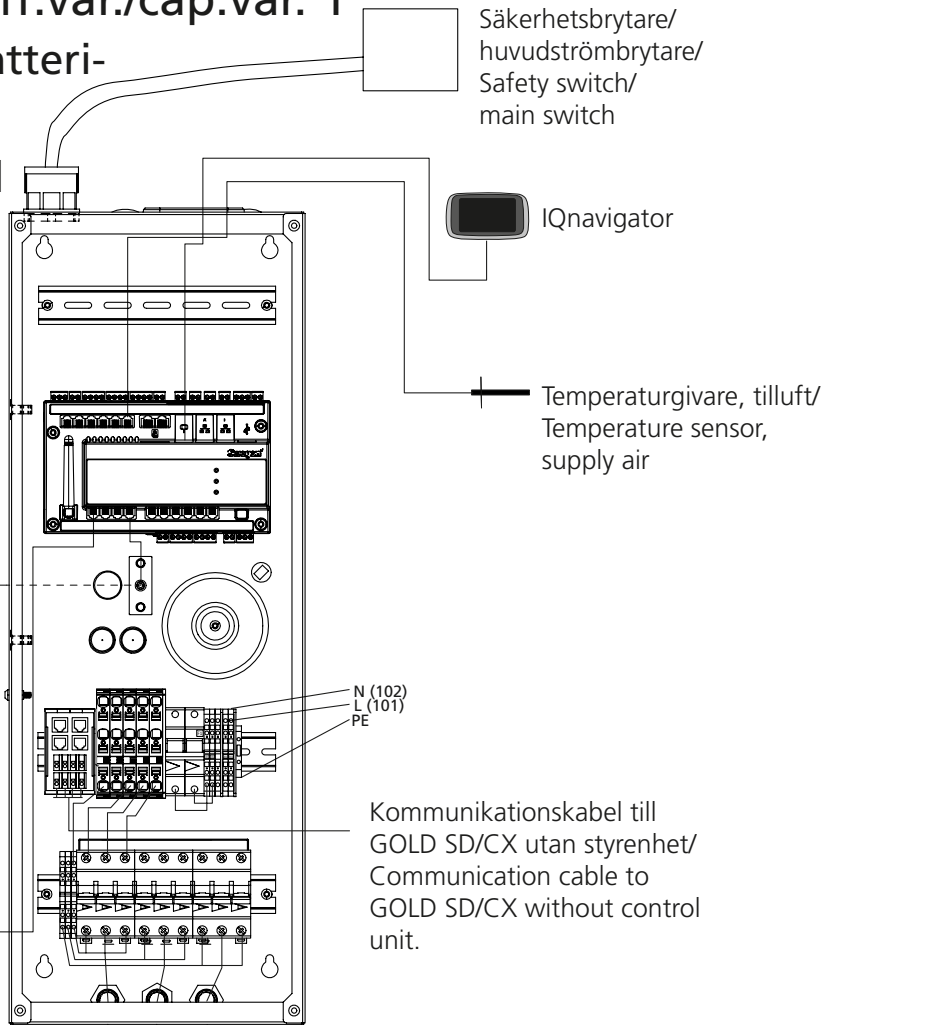

GOLD SD/CX 120, eff.var./cap.var. 1

Utan styrenhet, med batteri-
värmewäxlare/Without control
unit, with coil heat exch.

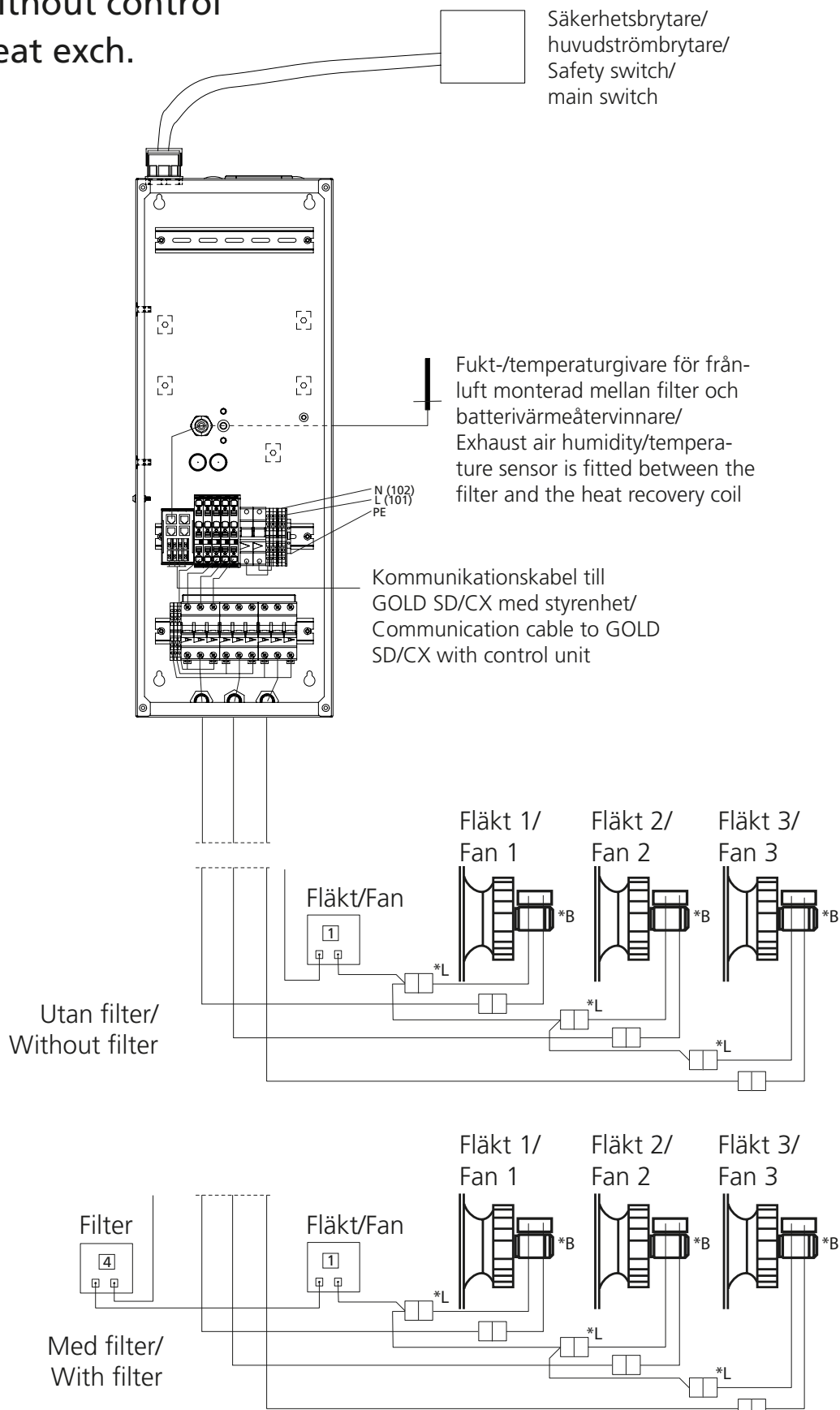

GOLD SD 120, eff.var./cap.var. 1

Sammankoppling av aggregat med styrenhet till aggregat utan styrenhet/

Connecting AHU with control unit to AHU without control unit

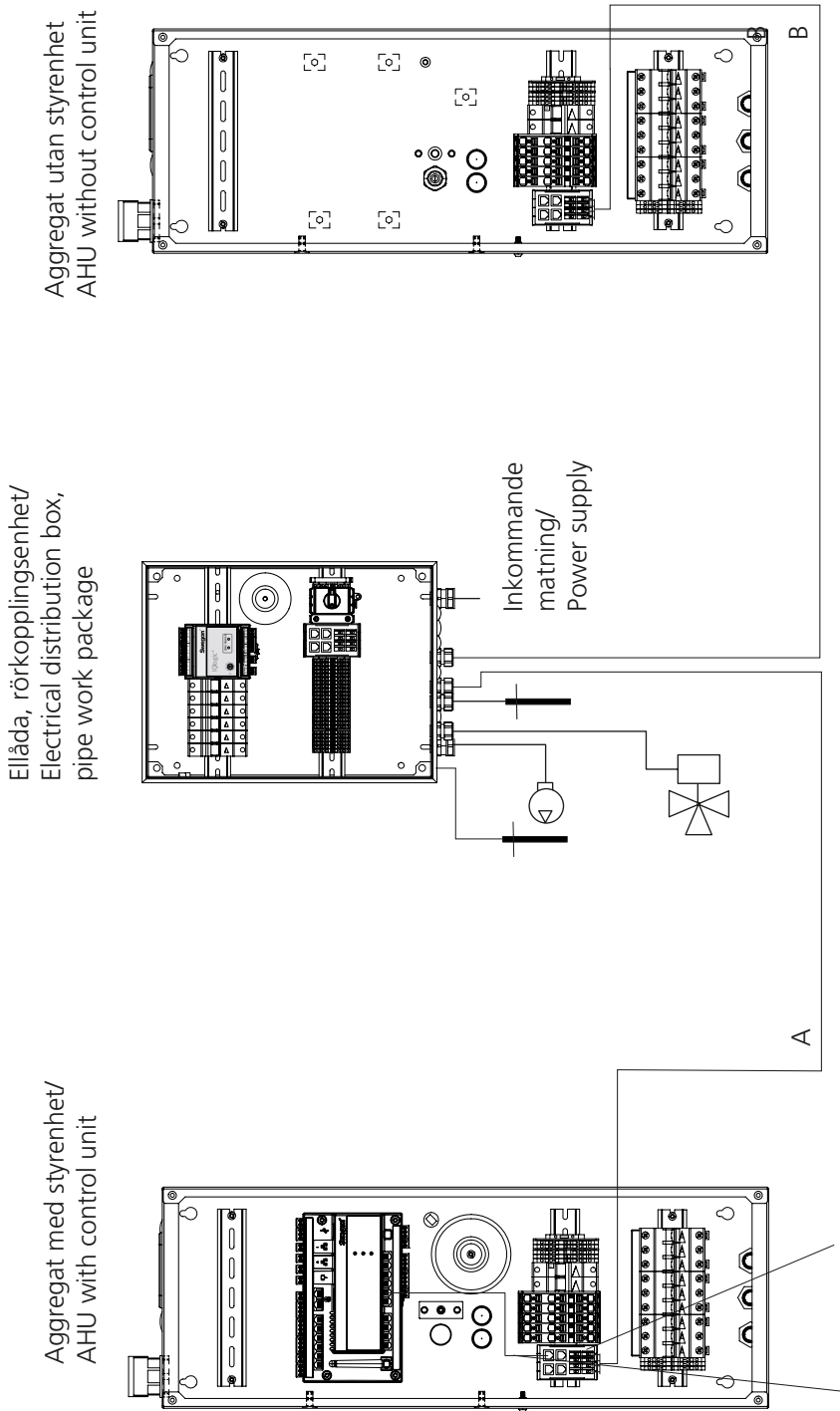

Aggregat utan styrenhet
AHU without control unit

Ellåda, rörkopplingsenhet/
Electrical distribution box,
pipe work package

Aggregat med styrenhet/
AHU with control unit

Partvinnad kommunikationskabel B min. 4x0,5 mm²
(Max totallängd kommunikationskabel A + B = 100 meter. Ingår ej i leverans)/
Twisted-pair communication cable B min. 4x0,5 mm² (Max total length communication cables A + B = 100 meters. Not included in delivery)

Kommunikationskabel B kan även anslutas på kabeladapter i ellådan på aggregatet med styrenhet om det underlättar installationen./
If it simplifies the installation, the communication cable B can also be connected to the cable adapter in the electrical distribution box of the AHU with control unit.

Partvinnad kommunikationskabel A min. 4x0,5 mm² (Max totallängd kommunikationskabel A + B = 100 meter. Ingår ej i leverans)/
Twisted-pair communication cable A min. 4x0,5 mm² (Max total length communication cables A + B = 100 meters. Not included in delivery)

Medlevererad bus-kabel/
Delivered bus cable
Kabeladapter för montering i ellåda med styrenhet levereras löst i ellådan utan styrenhet/
Cable adapter for mounting in electrical distribution box with control unit is delivered unmounted in the electrical distribution box without control unit

B: GOLD RX/PX/CX/SD 08/11 eff.var./cap.var. 2, 12-120

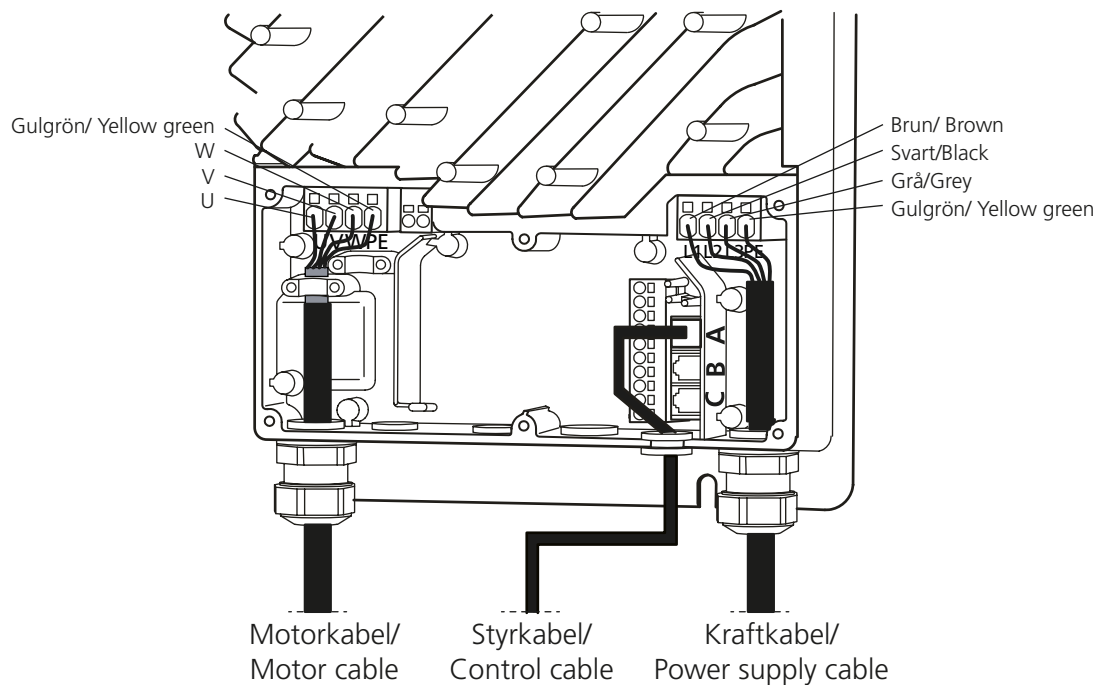

L: GOLD RX/PX/CX/SD 120

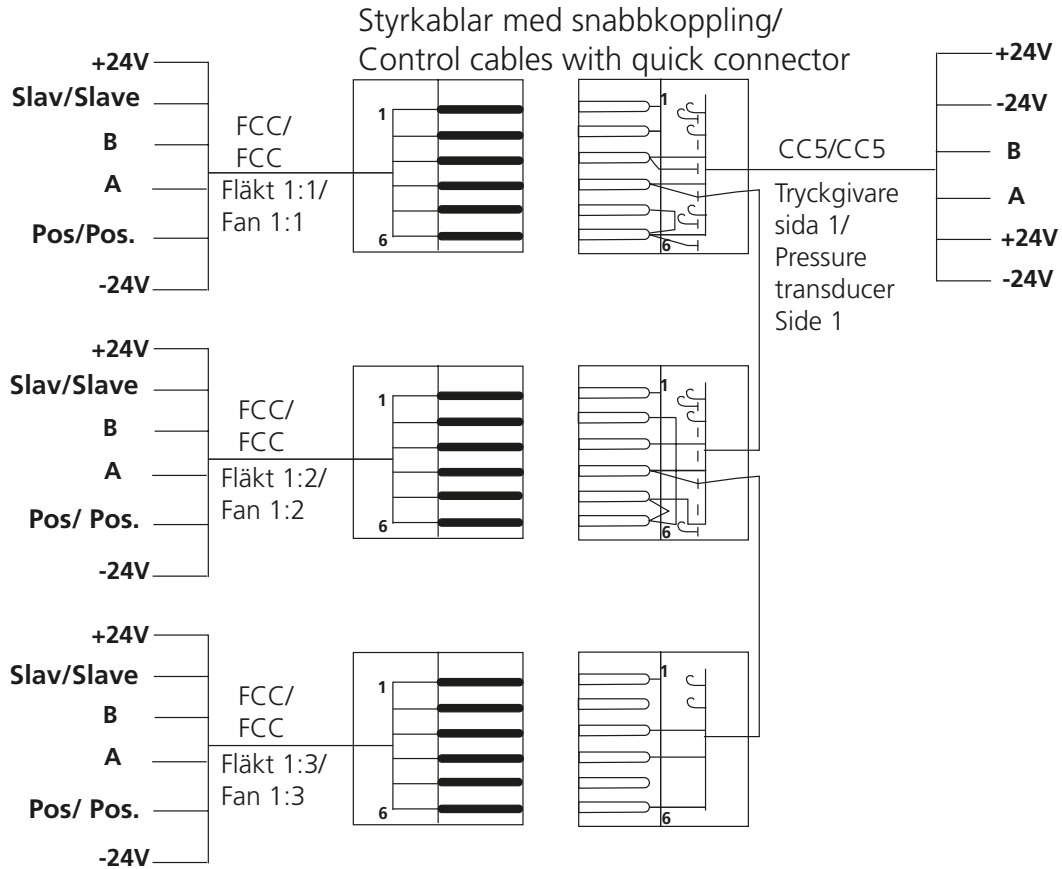

M: GOLD RX/PX/CX/SD 120

