

GOLD SD 100, eff.var./cap.var. 2
Med styrenhet, utan
batterivärmeväxlare/
With control
unit, without coil
heat exch.

Skiss visar styrenhet för aggregat med inspektionssida vänster, styrenhet för aggregat med inspektionssida höger ser något annorlunda ut, men principen är lika.
 The sketch shows control unit for AHU with left-hand inspection, control unit for AHU with right-hand inspection looks slightly different, but the principle is the same.

Temperaturgivare för densitetskorrigerat luftflöde/
 Temperature sensor for density corrected air flow

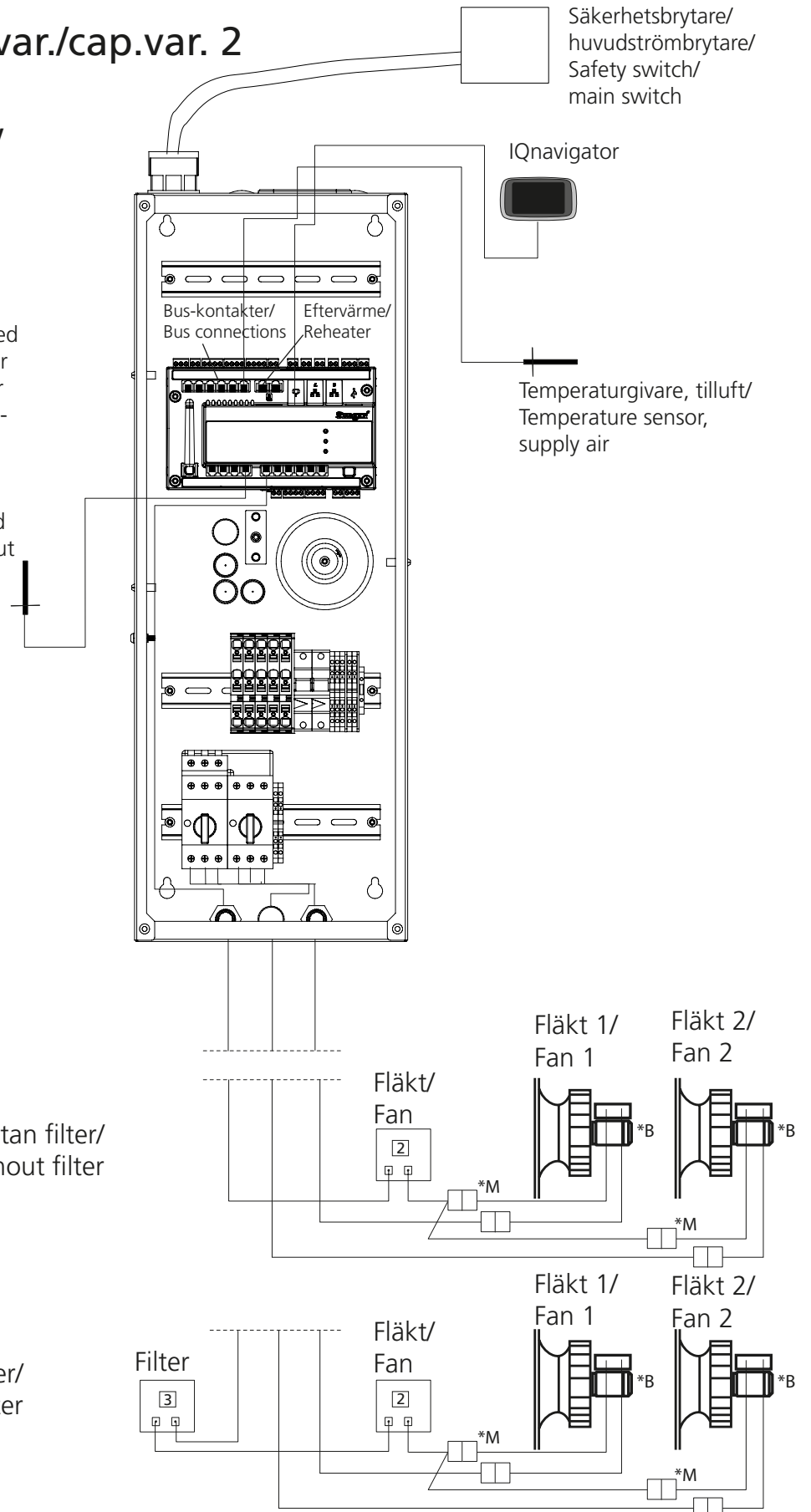

GOLD SD 100, eff.var./cap.var. 2

Utan styrenhet, utan

batterivärmeväxlare/

Without control

unit, without coil

heat exch.

Säkerhetsbrytare/
huvudströmbrytare/
Safety switch/
main switch

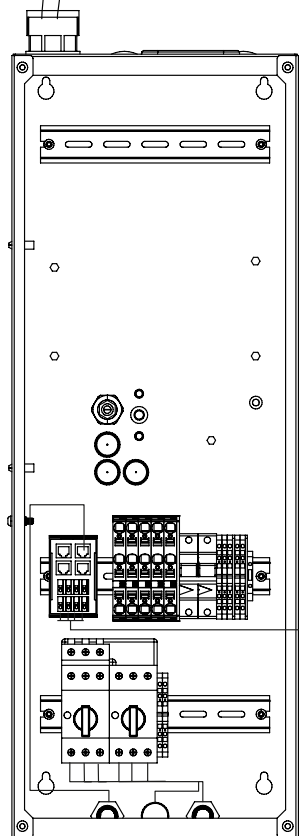
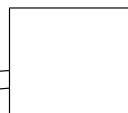

Kommunikationskabel till
GOLD SD med styrenhet/
Communication cable to
GOLD SD with control unit

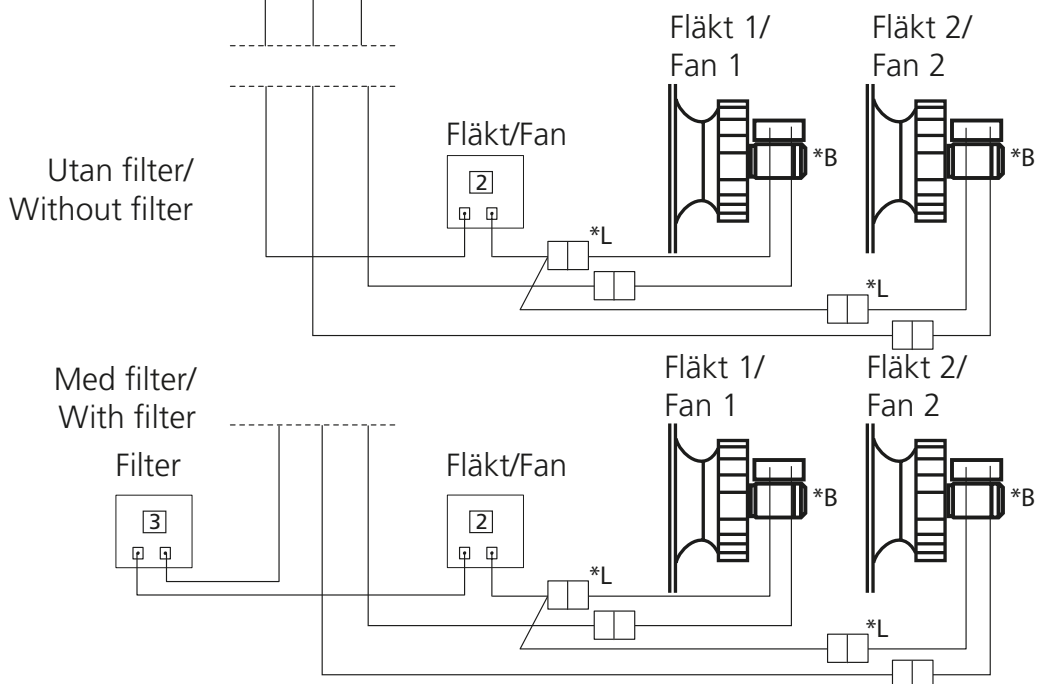

GOLD SD 100, eff.var./cap.var. 2

Sammankoppling av aggregat med styrenhet till aggregat utan styrenhet/

Connecting AHU with control unit to AHU without control unit

Aggregat utan styrenhet
AHU without control unit

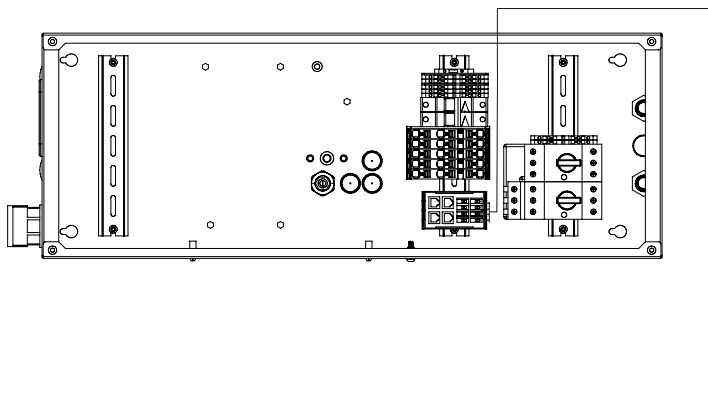

Aggregat med styrenhet/
AHU with control unit

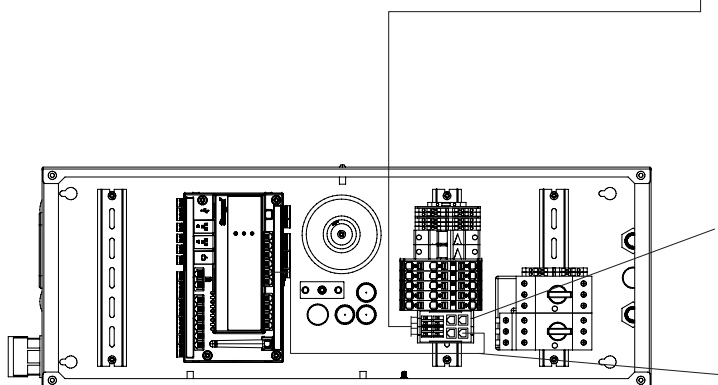

Partvinnad kommunikationskabel min. 4x0,5 mm², max 100 meter (ingår ej i leverans)/
Twisted-pair communication cable min. 4x0,5 mm², max 100 meters (not included in delivery)

Kabeladapter för montering i ellåda med styrenhet levereras löst i ellådan utan styrenhet/
Cable adapter for mounting in electrical distribution box with control unit is delivered unmounted in the electrical distribution box without control unit

Medlevererad bus-kabel/
Delivered bus cable

B: GOLD RX/PX/CX/SD 08/11 eff.var./cap.var. 2, 12-120

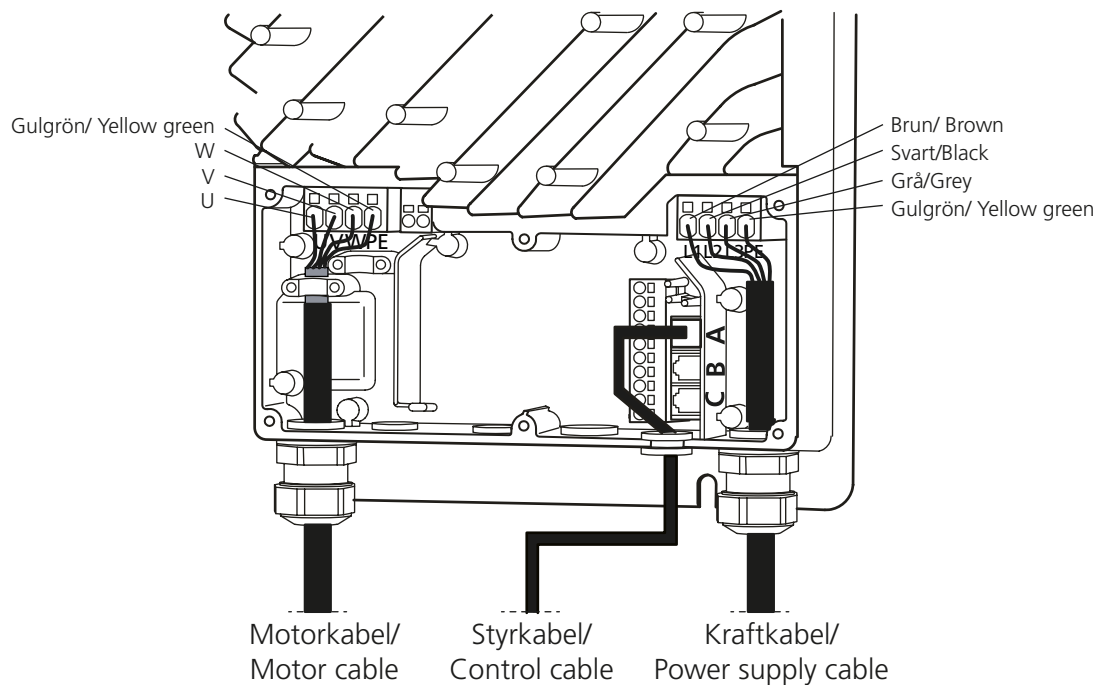

L: GOLD RX/PX/CX/SD 50-100

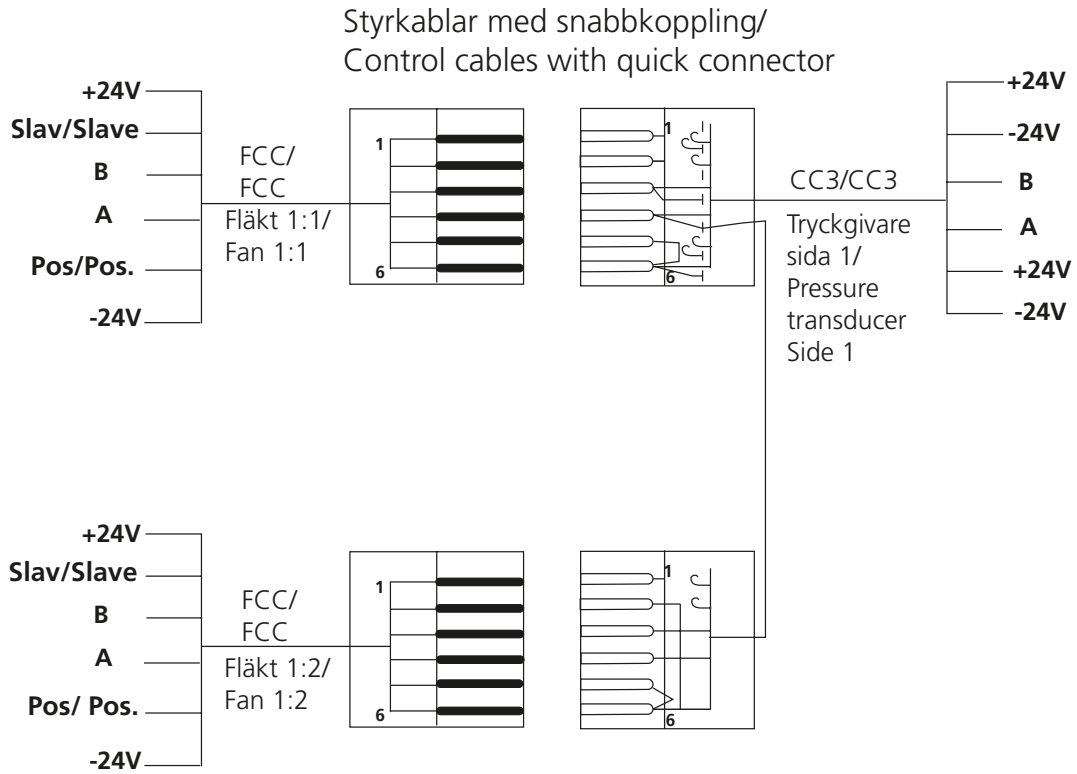

M: GOLD RX/PX/CX/SD 50-100

