

MORENDO

Rectangular sound attenuator with low installation height and tapered acoustic baffle surfaces



QUICK FACTS

- Can be used everywhere where rectangular sound attenuators are used
- Low installation height
- Low pressure drop via tapered acoustic baffle surfaces
- Type-approved insulation material, ISOVER Cleantec® PLUS
- ISOVER Cleantec® PLUS is cleanable using a wet method
- Available in a cleanable version
- Available with cleaning cover
- Connection sizes ranging from 150x150 to 400x1000 mm
- Included in the MagiCAD database

Technical description

General

the MORENDO is a rectangular sound attenuator with extra low installation height to enable it to be used in installations where available space is restricted.

Function

The MORENDO's low pressure drop has been achieved by designing the acoustic baffles according to the basic laws of aerodynamics by tapering the baffles. The low pressure drop can e.g. be utilised for the following:

- For reducing the space requirement in that a smaller sound attenuator can be selected.
- For reducing the pressure rise in the fan if the size is maintained.
- For reducing the inherent sound generation in the system thanks to lower velocity and lower pressure rise.
- For adapting the sound attenuator more easily to the connected duct system.

Design

- The MORENDO is made as standard of galvanized sheet steel to Environment Class C2 (corresponds to M2 according to Swedish VVS-AMA 98 Standard).
- The sound-attenuating material, ISOVER Cleantec® PLUS, is a type-approved insulation material consisting of long-fibred, compressed mineral wool which is covered with a special micro-perforated foil. ISOVER Cleantec® PLUS is type-approved with regard to cleaning, fibre entrainment, resistance to ageing, emissions, washable surfaces etc., to type-approval number 2706/92.
- The standard MORENDO is supplied with slip clamp connections.
- The MORENDO is available in an insulated version with 50 mm thick fire-resistant stone wool. In this version, all the insulating surfaces are covered with perforated sheet steel, MORENDO T3.
- If the air is severely polluted with particles or if for some other reason a more robust design is required, the acoustic baffles can be covered with perforated sheet steel over the ISOVER Cleantec® PLUS insulation, MORENDO T4.

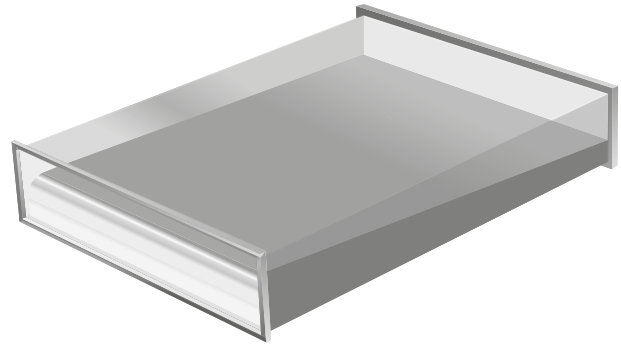

Figure 1. MORENDO with tapered acoustic baffles for low pressure drop.

Environment

The declaration of construction materials is available for downloading from our website or can be ordered from one of our sales offices.

Maintenance

The MORENDO is under normal operating conditions a maintenance-free sound attenuator. If periodic cleaning is required, the MORENDO can be ordered with cleaning cover.

Installation

The slip clamps on this product are designed for connection to ducts only. The product should be suspended with support under its entire width.

Accessories

Cleaning covers T1 and T2

For certain applications, a cleaning cover is required on or by the connection to the sound attenuator. For the MORENDO, this is available as accessories MORENDO T1 and T2 with cover which enables access to all the air passages between the baffles.

The acoustic data and pressure drop do not change if the MORENDO T1 or MORENDO T2 accessory is used.

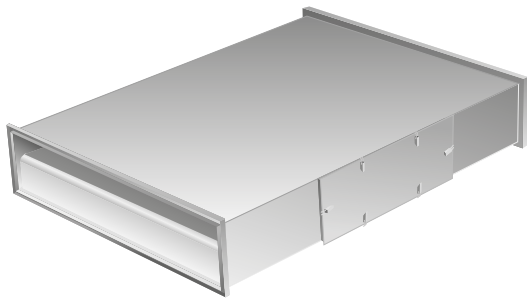

Figure 2. MORENDO with accessory MORENDO T1, un-insulated cleaning cover.

Cleaning cover accessory

MORENDO T1: Uninsulated cleaning cover
 150 (Fits to H-dim. 150)
 200-300 (Fits to H-dim. 200 to 300)
 350-500 (Fits to H-dim. 350 to 500)

MORENDO T2: Fire-resistant insulated cleaning cover, 50 mm thick stone wool

Perforated sheet metal lining T4

If the air contains a high concentration of particles or if for some other reason a more robust design is required, the acoustic baffles can be covered with perforated sheet steel over the ISOVER Cleantec® PLUS insulation, MORENDO T4.

The acoustic characteristics or pressure drop do not change if the MORENDO T4 accessory is used. The inherent sound generation increases, see correction K2 – inherent sound generation in the CALMO product datasheet.

Fire-resistant insulation accessory

MORENDO T4: Perforated sheet metal lining

Fire-resistant insulation T3

In many applications, sound attenuators are installed in fire resistant insulated duct systems. In applications in which ventilation ducts are to be insulated with 50 mm thick fire-resistant stone wool, the fitter can either install external insulation onto the sound attenuator directly at the building site or place an order for the factory-insulated variant.

For the MORENDO, the factory-insulated variant is available as an accessory.

You can choose to insulate the cleaning cover only (MORENDO T2) or insulate the whole sound attenuator (MORENDO T3).

The acoustic data do not change if the MORENDO T3 accessory is used. The pressure drop increases because the fire-resistant insulation reduces the amount of free area. The reduction in free area is specified in Diagram 1. See also Figure 3 below.

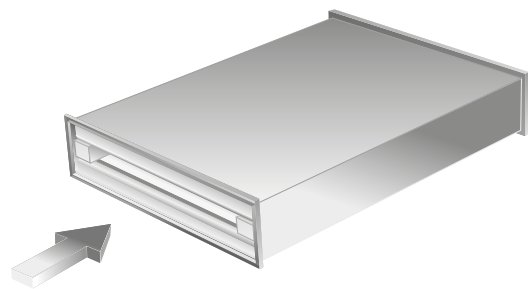

Figure 3. MORENDO with accessory MORENDO T3, fire-resistant insulated.

Fire-resistant insulation accessory

MORENDO T3: Fire-resistant insulated 50 mm thick stone wool

Flange connection T5

Available as an alternative to slip-clamp connection. Has robust flanges made of galvanized angle steel, with oval bolt holes designed to facilitate installation.

Flange connection accessories

MORENDO T5: Flange connection

Sizing

General

The specified "Technical Data" apply to MORENDO in the standard version. If perforated sheet steel covers the acoustic baffle surfaces, this increases the inherent sound generation.

The specified data are based on a uniform air stream in and out of the sound attenuator. Any dampers, duct bends or other products in the ducting near the sound attenuator will increase its pressure drop and level of inherent sound generation, and can affect its sound attenuating performance.

Dimensions

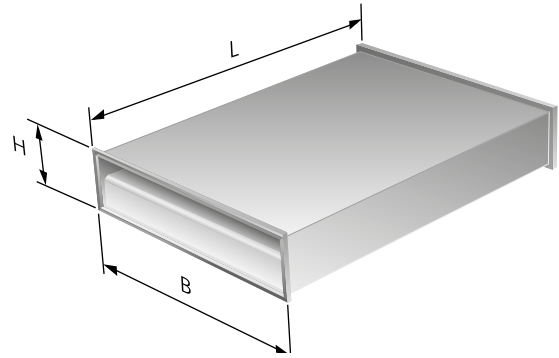

Figure 4. Dimension print

- H dim.: 150, 200, 250, 300, 350, 400
- B dim.: 150, 200, 250, 300, 400, 500, 600, 700, 800, 900, 1000
- L dim.: 650, 950, 1250
- Weight: Contact your nearest Swegon Representative.

Technical Data

H dim. (mm)	Code	Length (mm)	Static integral attenuation, (dB) to ISO 7235								P-value
			63	125	250	500	1K	2K	4K	8K	
150	0151	650	3	7	15	25	34	34	21	17	6.1
	0152	950	5	10	23	34	42	40	27	21	7.1
	0153	1250	6	12	31	43	50	45	32	24	8,1
200	0201	650	3	6	11	19	26	24	15	11	1.8
	0202	950	4	8	16	27	35	32	26	14	2.0
	0203	1250	4	10	21	34	44	40	36	17	2.1
250	0251	650	3	7	13	20	26	22	14	11	2.0
	0252	950	4	9	17	27	33	28	18	14	2.2
	0253	1250	5	10	21	34	39	34	21	16	2.3
300	0301	650	4	8	13	21	25	25	13	8	2.9
	0302	950	5	11	18	29	34	32	17	12	3.2
	0303	1250	6	13	22	37	43	38	21	15	3.5
350	0351	650	3	7	11	16	19	17	9	8	1.5
	0352	950	4	9	15	23	27	23	12	10	1.7
	0353	1250	5	11	18	29	35	29	14	12	1.9
400	0401	650	4	8	12	18	22	20	11	8	2.7
	0402	950	5	10	15	25	29	25	13	10	3.2
	0403	1250	6	12	19	32	37	31	15	12	3.5

Dimension/Sound attenuation

- Calculate the required sound attenuation manually or use Swegon's ProAc acoustic calculation software (available at our home page).
- Select sound attenuators that will meet the calculated sound attenuation requirement under Technical Data.
- Check the B dimension of the sound attenuator to optimize the pressure drop; observe the system effect too (see the product datasheet for the CALMO).
- The p-value read under Technical Data is used for determining the pressure drop of the sound attenuator. The higher the p-value, the higher the pressure drop, see Nomogram 1.

For the MORENDO in the fire-resistant version, proceed from corrected gross face area in step 4 above, see Diagram 1.

For the rest, the sizing procedure above applies.

Pressure drop

- Calculate the gross face area, $B \times H$ (m²).
- Find the contemplated airflow in Nomogram 1.
- Go vertically upward to the p-value obtained for the selected sound attenuator under Technical Data.
- Read the pressure drop that refers to duct/duct installation.
- If you select an alternative other than duct/duct, correct the pressure drop using Diagram 2.

Nomogram 1. Determining the pressure drop

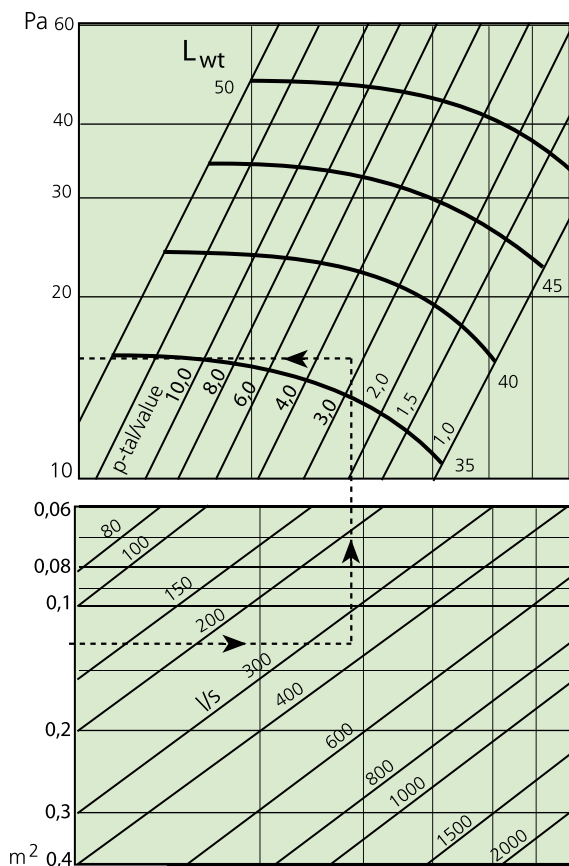
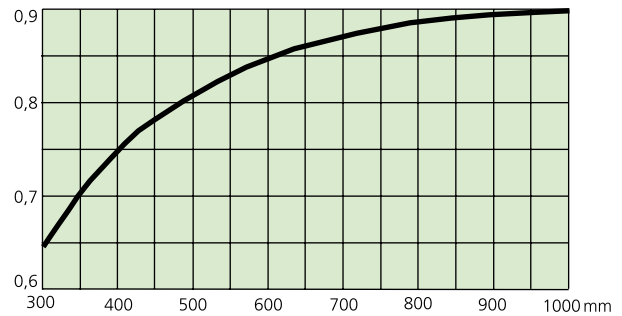

Diagram 1. Correction for overall area for fire-resistant insulated sound attenuator



Since the MORENDO in the fire-resistant insulated version has all its internal sides insulated, the amount of free area will be less than for a non-fire-resistant insulated model. The selected sound attenuator's gross area should be corrected according to the adjacent diagram depending on the relevant width.

Example:

A sound attenuator is positioned in a branch duct. The airflow is 350 l/s and the sound attenuator is mounted in a duct having a height of 300 mm. The MORENDO 302 sound attenuator with p-value 3.2 has been selected from Technical Data. The sound attenuator is 400 mm wide and 300 mm high. The gross face area will be 0.12 m². Nomogram 1 gives a pressure drop of approx. 16 Pa.

Diagram 2. Correction for different connection

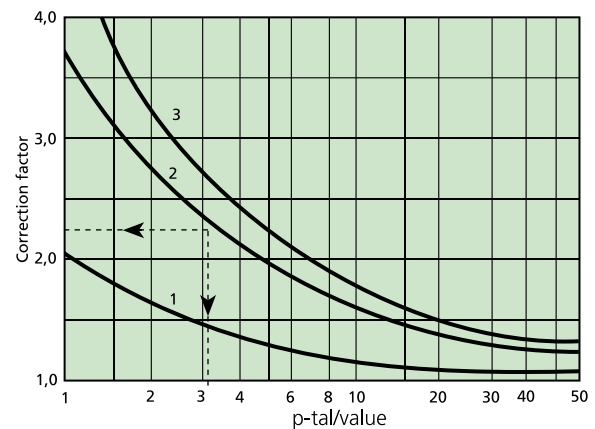

Curve 1: Plenum/Duct; Curve 2: Duct/Plenum, Curve 3: Plenum/Plenum

Inherent sound generation

When the air flows at high velocity, inherent sound is generated as a result of turbulence. Normally no problems will occur if the air velocity through the gross area is kept under 4 m/s.

For particulars on the specification of inherent sound generation we refer to our ProAc acoustic calculation software, which is available for downloading from our home page.

Ordering key

Product

Rectangular sound attenuator

MORENDO a aaa- bbbb x cccc x dddd

Version:

Code

According to Technical Data

Mimensions:

Width x height x length (mm)

Specification text

Example of a specification text conforming to Swedish VVS AMA 12 Standard.

Swegon's type MORENDO rectangular sound attenuator, with the following attributes:

- Low installation height
- Tapered acoustic baffles
- Type-approved insulation material, ISOVER Cleantec® PLUS
- Sound attenuation in dB (to be specified in clear text for the various frequency bands).
- Pressure drop in Pa (to be specified in clear text).

Size: MORENDO aaa - bbbb x cccc x dddd xx items etc.

Accessories

- MORENDO T1 = Uninsulated cleaning cover
- MORENDO T2 = Fire-resistant insulated cleaning cover, 50 mm thick stone wool
- MORENDO T3 = Fire-resistant insulated 50 mm thick stone wool
- MORENDO T4 = Perforated sheet metal lining
- MORENDO T5 = Flange connection